

GOLF CART SEAT COVERS INSTRUCTION



GOLF CART





**If there any issue with it, don't hesitate to
contact us via Amazon message
Your satisfaction is our greatest motivation!**

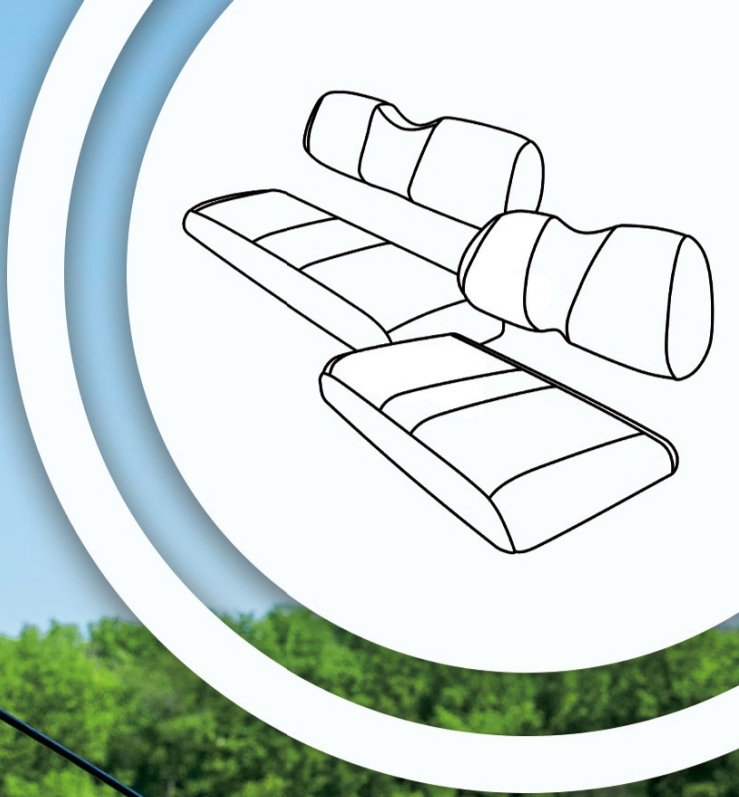

**GOLF CART
SEAT COVERS
INSTALLATION
MANUAL**



INSTALLATION INSTRUCTION OF GOLF CART FRONT SEAT COVERS

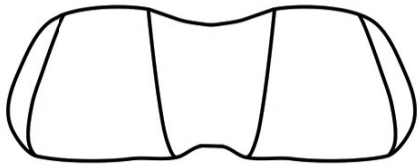

..... Front backrest cover

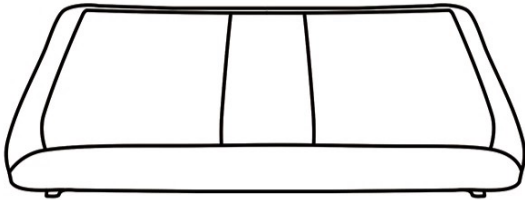

..... Front bench seat cover

(Take the installation front seat of Club Car precedent golf cart as an example)

INSTALLATION STEPS OF FRONT BACKREST SEAT COVERS

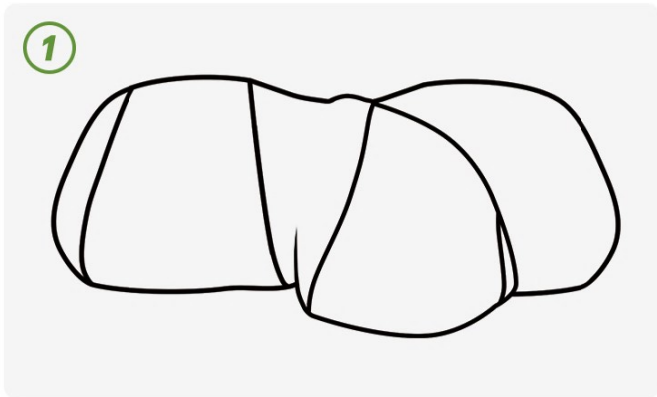

1 Slip the backrest seat cover over the front seat backrest

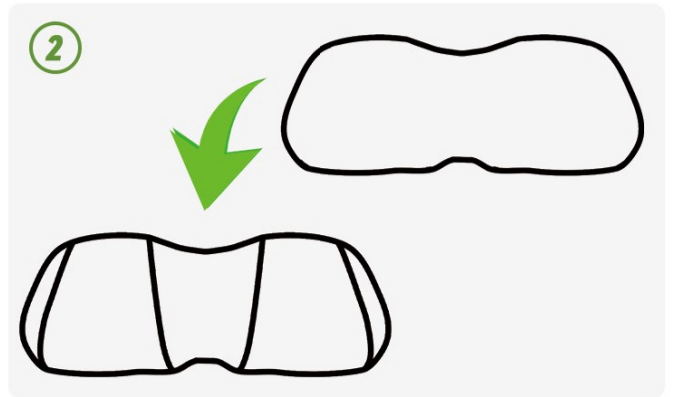

2 The narrow end of the backrest seat cover is at the upper end of the corresponding backrest

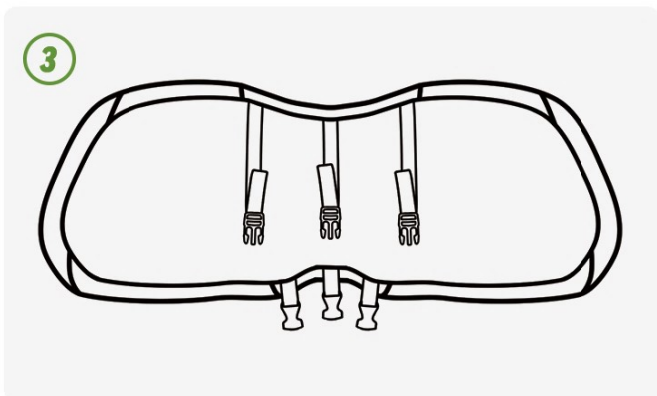

3 Stretch the backrest seat cover and slip it cover the backrest

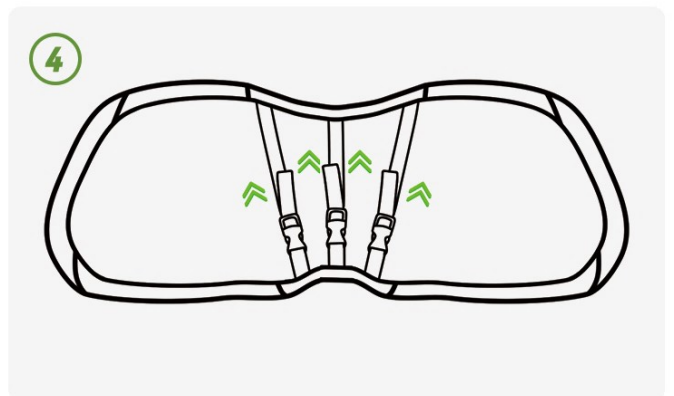

4 Close the clasp and the backrest seat cover is installed completely.



INSTALLATION STEPS OF FRONT BENCH SEAT COVERS

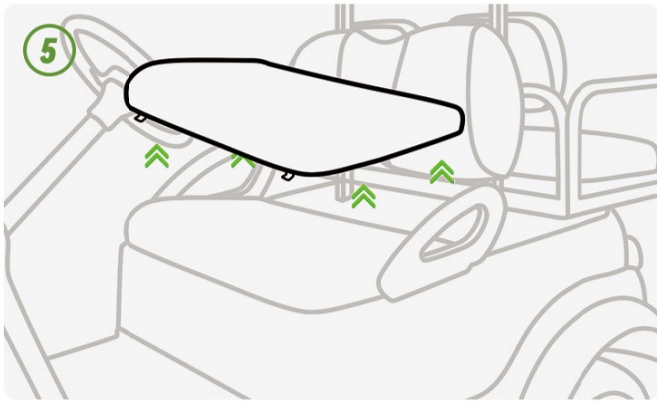

Remove both handrails and take out the golf cart front seat cushion

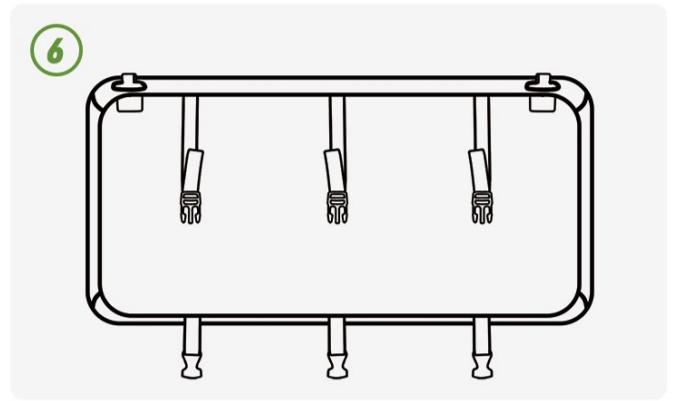

Slip the bench seat cover over the bench seat cushion, and the buckle corresponds to the seat cushion clip

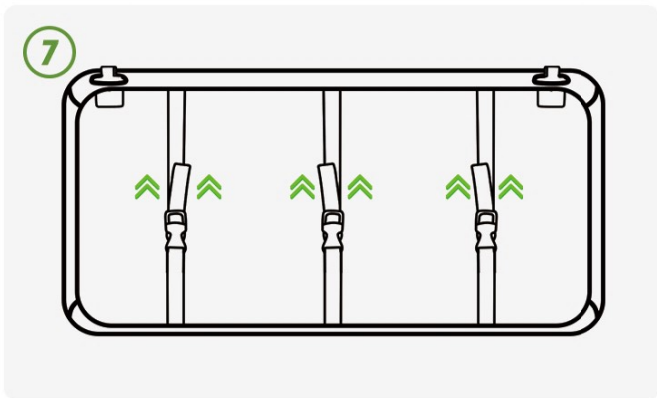

Close the clasp and pull it tight

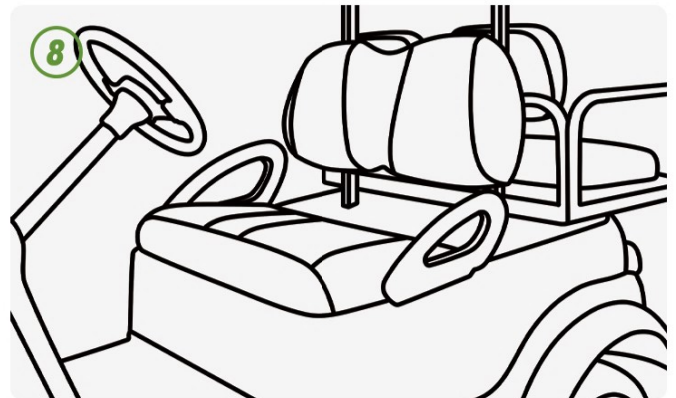

Install the handrails on the seat cushion and then install the seat cushion on the golf cart. The front seat cover is installed completely

! Warm Tip: Club Car DS/Precedent/EZGO RXV/Yamaha G29 Golf cart..... installation instruction are similar to those in EZGO TXT



INSTALLATION INSTRUCTION OF GOLF CART REAR SEAT COVERS

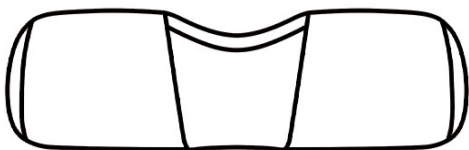

Rear Backrest Cover

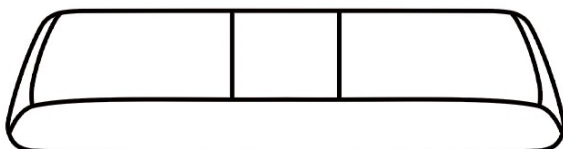

Rear bench Seat Cover

(rear seat covers are universal to most golf cart models)



INSTALLATION STEPS OF REAR SEAT COVERS

9

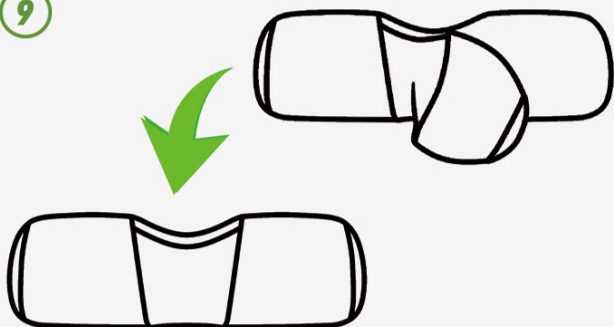

Slip the backrest rear seat cover over the rear seat backrest.

10



Remove the back bench seat cushion.

11

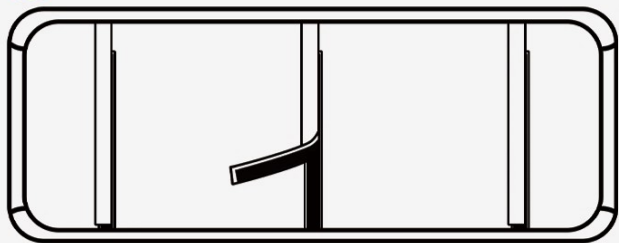

Slip the bench seat cover over the back seat cushion and attach Velcro.

12

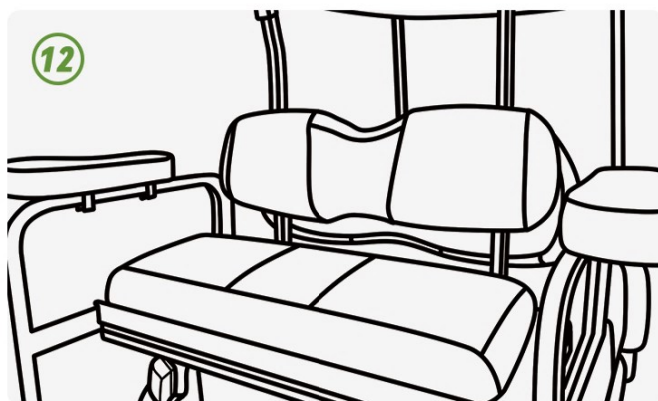

Reinstall the rear seat cushion. The rear seat cover is installed completely.

! Installation Steps of Rear Backrest Cover, Same as the Front Backrest Cover



3

